

WELLGROW INDUSTRIES CORP.

Handrail and Balustrade Fittings



HANDRAIL & RAILING FITTINGS

WELLGROW INDUSTRIES CORP.

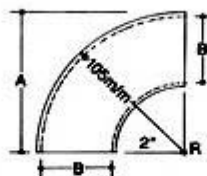

JOINER 90° RADIUSED

| Model No. | Size |
|-----------|---|
| 1501D | B1 ¹ / ₂ " x A3" |
| 2001D | B2" x A4" |
| 2501D | B2 ¹ / ₂ " x A4 ³ / ₄ " |

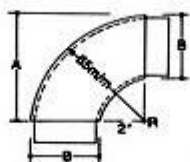

FLUSH JOINER 90° RADIUSED

| Model No. | Size |
|-----------|---|
| 1501E | B1 ¹ / ₂ " x A2 ⁵ / ₈ " |
| 2001E | B2" x A2 ⁵ / ₈ " |
| 2501E | B2 ¹ / ₂ " x A3" x R65m/m |
| 2501EL | B2 ¹ / ₂ " x A4" x R110m/m |
| 3001E | B3" x A4 ³ / ₈ " x R110m/m |

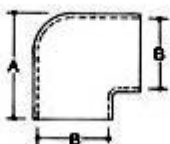

JOINER 90°

| Model No. | Size |
|-----------|---|
| 1502D | B1 ¹ / ₂ " x A2 ³ / ₈ " |
| 2002D | B2" x A3" |

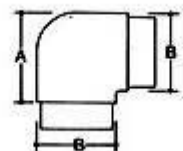

FLUSH JOINER 90°

| Model No. | Size |
|-----------|--|
| 1502E | B1 ¹ / ₂ " x A2" |
| 2002E | B2" x A2 ¹ / ₄ " |

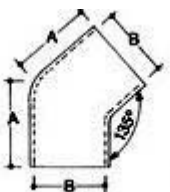

JOINER 135°

| Model No. | Size |
|-----------|---|
| 1503D | B1 ¹ / ₂ " x A2" |
| 2003D | B2" x A2 ³ / ₈ " |
| 1503DD | B1 ¹ / ₂ " x A2" Custom-Angle |
| 2003DD | B2" x A2 ³ / ₈ " Custom-Angle |

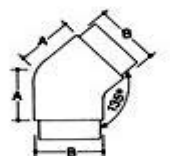

FLUSH JOINER 135°

| Model No. | Size |
|-----------|--|
| 1503E | B1 ¹ / ₂ " x A29mm |
| 2003E | B2" x A1 ³ / ₄ " |
| 1503EE | B1 ¹ / ₂ " x A1 ⁵ / ₈ " Custom-Angle |
| 2003EE | B2" x A2 ³ / ₄ " Custom-Angle |

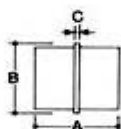
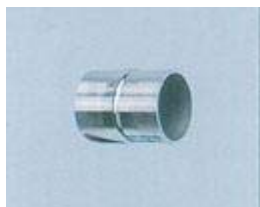

FLUSH JOINER IN-LINE

| Model No. | Size |
|-----------|---|
| 1504E | B1 ¹ / ₂ " x A2" x C ¹ / ₈ " |
| 2004E | B2" x A2 ¹ / ₈ " x C ¹ / ₈ " |
| 2504E | B2 ¹ / ₂ " x A2 ⁵ / ₈ " x C ¹ / ₈ " |
| 3004E | B3" x A2 ⁵ / ₈ " x C ¹ / ₈ " |

HANDRAIL & RAILING FITTINGS

WELLGROW INDUSTRIES CORP.

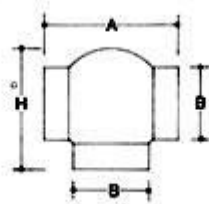

JOINER BALL TEE

| Model No. | Size |
|-----------|---|
| 2005B | B2" x A3 ⁵ / ₈ " x H3 ³ / ₈ " |

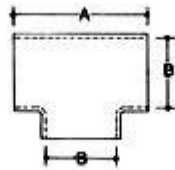

JOINER TEE

| Model No. | Size |
|-----------|--|
| 1505D | B1 ¹ / ₂ " x A3 ¹ / ₄ " x C1 ¹ / ₂ " |
| 2005D | B2" x A3 ³ / ₄ " x C2" |

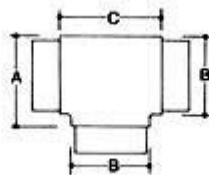

FLUSH JOINER TEE

| Model No. | Size |
|-----------|---|
| 1505E | B1 ¹ / ₂ " x A2" x C2 ³ / ₈ " |
| 2005E | B2" x A2 ¹ / ₄ " x C2 ⁵ / ₈ " |

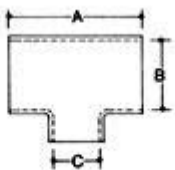

JOINER TEE

| Model No. | Size |
|-----------|---|
| 1505H | B1 ¹ / ₂ " x A3 ¹ / ₄ " x C1" |
| 2005H | B2" x A3 ³ / ₄ " x C1 ¹ / ₂ " |

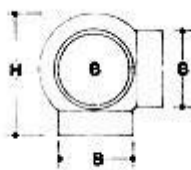

FLUSH JOINER 90° BALL TEE

| Model No. | Size |
|-----------|--|
| 2006B | B2" x H3 ³ / ₈ " |

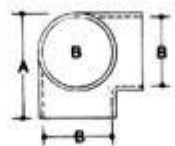

JOINER 90° TEE

| Model No. | Size |
|-----------|---|
| 1506D | B1 ¹ / ₂ " x A2 ³ / ₈ " |
| 2006D | B2" x A3" |

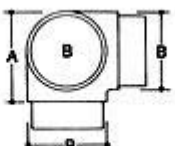

FLUSH JOINER 90° TEE

| Model No. | Size |
|-----------|--|
| 1506E | B1 ¹ / ₂ " x A2" |
| 2006E | B2" x A2 ¹ / ₄ " |

HANDRAIL & RAILING FITTINGS

WELLGROW INDUSTRIES CORP.

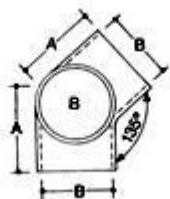

JOINER 135° TEE

| Model No. | Size |
|-----------|---|
| 1507D | B1 ¹ / ₂ " x A2" |
| 2007D | B2" x A2 ³ / ₈ " |
| 1507DD | B1 ¹ / ₂ " x A2" Custom-Angle |
| 2007DD | B2" x A2 ³ / ₈ " Custom-Angle |

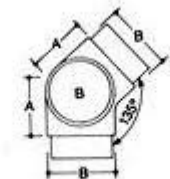

FLUSH JOINER 135° TEE

| Model No. | Size |
|-----------|--|
| 1507E | B1 ¹ / ₂ " x A1 ⁵ / ₈ " |
| 2007E | B2" x A1 ³ / ₄ " |
| 1507EE | B1 ¹ / ₂ " x A1 ⁵ / ₈ " Custom-Angle |
| 2007EE | B2" x A1 ³ / ₄ " Custom-Angle |

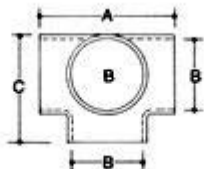

JOINER 4-WAY TEE

| Model No. | Size |
|-----------|---|
| 1508D | B1 ¹ / ₂ " x A3 ¹ / ₄ " x C2 ³ / ₈ " Adj. Types |
| 2008D | B2" x A3 ³ / ₄ " x C3" Adj. Types |

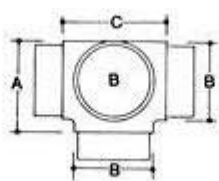

FLUSH JOINER 4-WAY TEE

| Model No. | Size |
|-----------|---|
| 1508E | B1 ¹ / ₂ " x A2" x C2 ³ / ₈ " |
| 2008E | B2" x A2 ¹ / ₄ " x C2 ⁵ / ₈ " |

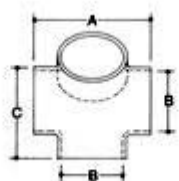

JOINER 4-WAY 135° ANGLE ADJUSTABLE CROSS

| Model No. | Size |
|-----------|--|
| 1509D | B1 ¹ / ₂ " x A3 ¹ / ₄ " x C2 ³ / ₈ " |
| 2009D | B2" x A3 ³ / ₄ " x C3" |
| 1509DL | B1 ¹ / ₂ " x A3 ¹ / ₄ " x C2 ³ / ₈ " |
| 2009DL | B2" x A3 ³ / ₄ " x C3" |

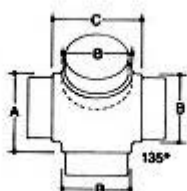

FLUSH JOINER 4-WAY 135° ANGLE CROSS

| Model No. | Size |
|-----------|--|
| 1509E | B1 ¹ / ₂ " x A2" x C2 ³ / ₈ " |
| 2009E | B2" x A2 ¹ / ₄ " x C2 ⁵ / ₈ " |
| 1509EL | B1 ¹ / ₂ " x A2" x C2 ³ / ₈ " Adj. Types |
| 2009EL | B2" x A2 ¹ / ₄ " x C2 ⁵ / ₈ " Adj. Types |

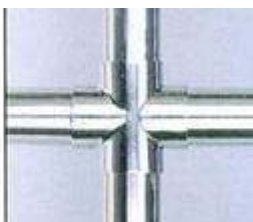
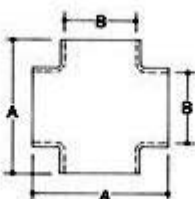

JOINER 4-WAY CROSS

| Model No. | Size |
|-----------|---|
| 1510D | B1 ¹ / ₂ " x A3 ¹ / ₄ " |
| 2010D | B2" x A3 ³ / ₄ " |

HANDRAIL & RAILING FITTINGS

WELLGROW INDUSTRIES CORP.

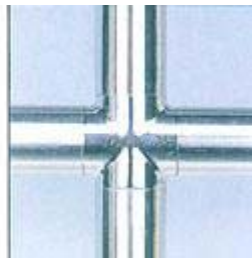
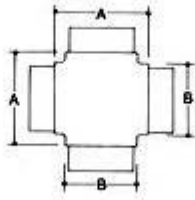
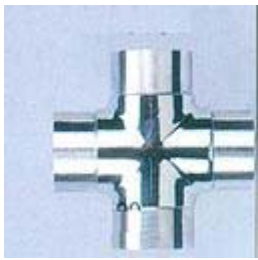

FLUSH JOINER 4-WAY CROSS

| Model No. | Size |
|-----------|---|
| 1510E | B1 ¹ / ₂ " x A2 ³ / ₈ " |
| 2010E | B2" x A2 ⁵ / ₈ " |

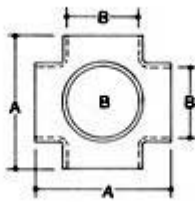

JOINER 5-WAY CROSS

| Model No. | Size |
|-----------|---|
| 1511D | B1 ¹ / ₂ " x A3 ¹ / ₄ " |
| 2011D | B2" x A3 ³ / ₄ " |

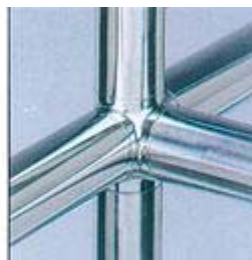
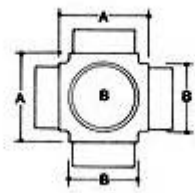

FLUSH JOINER 5-WAY CROSS

| Model No. | Size |
|-----------|---|
| 1511E | B1 ¹ / ₂ " x A2 ³ / ₈ " |
| 2011E | B2" x A2 ⁵ / ₈ " |

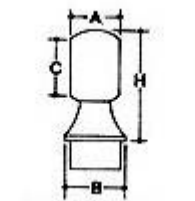

PERPENDICULAR JOINER THROUGH RING

| Model No. | Size |
|--|--|
| 1513AxC1 ¹ / ₂ " | B1 ¹ / ₂ " x C1 ¹ / ₂ " x H2 ³ / ₄ " |
| 1513AxC2" | B1 ¹ / ₂ " x C2" x H2 ³ / ₄ " |
| 2013AxC1 ¹ / ₂ " | B2" x C1 ¹ / ₂ " x H3 ¹ / ₂ " |
| 2013AxC2" | B2" x C2" x H3 ¹ / ₂ " |

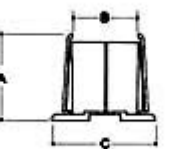

ROUND ADJUSTABLE HEAVY DUTY BASE PLATE

| Model No. | Size |
|---------------------------------------|--|
| 1099B-1" | B1" x A1 ¹ / ₈ " x C1 ⁵ / ₈ " |
| 1299B-1 ¹ / ₄ " | B1 ¹ / ₄ " x A1 ¹ / ₂ " x C2" |
| 1599B-1 ¹ / ₂ " | B1 ¹ / ₂ " x A1 ³ / ₄ " x C2 ¹ / ₄ " |
| 2099B-2" | B2" x A1 ⁷ / ₈ " x C3" |
| 2599B-2 ¹ / ₂ " | B2 ¹ / ₂ " x A2" x C3 ³ / ₄ " |

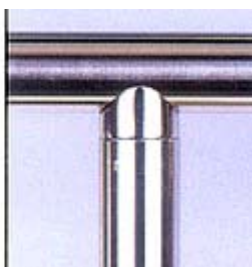
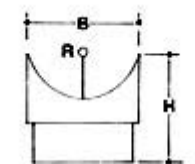

PERPENDICULAR JOINER FLUSH FITTING

| Model No. | Size |
|--|--|
| 1527AxR1 ¹ / ₂ " | B1 ¹ / ₂ " x R1 ¹ / ₂ " x H1 ³ / ₄ " |
| 1527AxR2" | B1 ¹ / ₂ " x R2" x H1 ³ / ₄ " |
| 1527AxR2 ¹ / ₂ " | B1 ¹ / ₂ " x R2 ¹ / ₂ " x H1 ¹ / ₂ " |

HANDRAIL & RAILING FITTINGS

WELLGROW INDUSTRIES CORP.

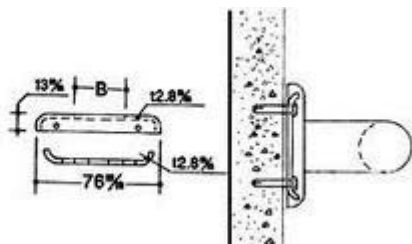

ROUND BASE PLATE WITH COVER

| Model No. | Size |
|-----------|----------------------------------|
| 1068 | B1" |
| 1268 | B1 ¹ / ₄ " |
| 1568 | B1 ¹ / ₂ " |
| 2068 | B2" |

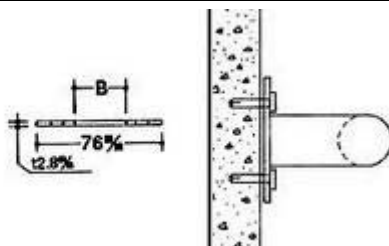

ROUND BASE PLATE

| Model No. | Size |
|-----------|----------------------------------|
| 1069 | B1" |
| 1269 | B1 ¹ / ₄ " |
| 1569 | B1 ¹ / ₂ " |

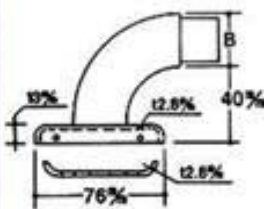

| Model No. | Size |
|-----------|--|
| 1270 | B1 ¹ / ₄ " |
| 1570 | B1 ¹ / ₂ " |
| 1270T | B1 ¹ / ₄ " Ti-plated |
| 1570T | B1 ¹ / ₂ " Ti-plated |

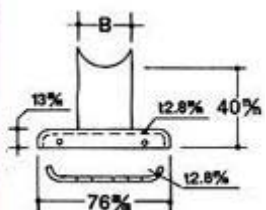

| Model No. | Size |
|-----------|--|
| 1271 | B1 ¹ / ₄ " |
| 1571 | B1 ¹ / ₂ " |
| 1271T | B1 ¹ / ₄ " Ti-plated |
| 1571T | B1 ¹ / ₂ " Ti-plated |

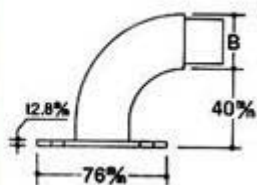

| Model No. | Size |
|-----------|----------------------------------|
| 1272 | B1 ¹ / ₄ " |
| 1572 | B1 ¹ / ₂ " |

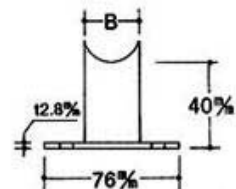

| Model No. | Size |
|-----------|----------------------------------|
| 1273 | B1 ¹ / ₄ " |
| 1573 | B1 ¹ / ₂ " |

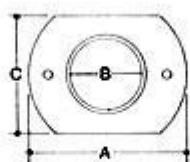

| Model No. | Size |
|-----------|--|
| 1514A | B1 ¹ / ₂ " x A3" x C2 ¹ / ₄ " x H1" |
| 2014A | B2" x A4" x C2 ³ / ₄ " x H1 ¹ / ₄ " |
| 2514A | B2 ¹ / ₂ " x A5" x C3 ³ / ₈ " x H1 ¹ / ₂ " |

HANDRAIL & RAILING FITTINGS

WELLGROW INDUSTRIES CORP.

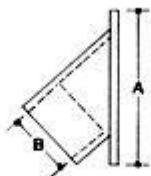

WALL STOP FLANGE ADJ. ANGLE 122°-135°

| Model No. | Size |
|-----------|--|
| 1515A | B1 ¹ / ₂ " x A3 ¹ / ₂ " x W2 ¹ / ₄ " |
| 2015A | B2" x A4 ¹ / ₂ " x W2 ³ / ₄ " |
| 2515A | B2 ¹ / ₂ " x A5" x W3 ¹ / ₄ " |

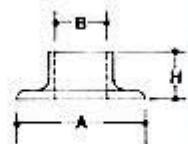

ROUND BASE PLATE/ FLANGE

| Model No. | Size |
|-----------|---|
| 1516A | B1 ¹ / ₂ " x A3" x H1" |
| 2016A | B2" x A4" x H1 ¹ / ₄ " |
| 2516A | B2 ¹ / ₂ " x A5" x H1 ¹ / ₂ " |
| 3016A | B3" x A6" x H1 ³ / ₄ " |

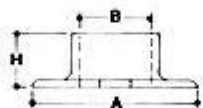

ROUND BASE PLATE/ FLANGE

| Model No. | Size |
|-----------|---|
| 1517A | B1 ¹ / ₂ " x A3" x H1" |
| 2017A | B2" x A4" x H1 ¹ / ₄ " |
| 2517A | B2 ¹ / ₂ " x A5" x H1 ¹ / ₂ " |
| 3017A | C3" x A6" x H1 ³ / ₄ " |



| Model No. | Size |
|-----------|---|
| 1524A | B1 ¹ / ₂ " x A3" x C3 ¹ / ₂ " |
| 2024A | B2" x A4" x C3 ³ / ₄ " |
| 2524A | B2 ¹ / ₂ " x A5" x C4 ⁵ / ₈ " |

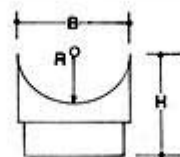

PERPENDICULAR JOINER FLUSH FITTING

| Model No. | Size |
|--|--|
| 2027A x R2" | B2" x R2" x H2 ¹ / ₄ " |
| 2027A x R2 ¹ / ₂ " | B2" x R2 ¹ / ₂ " x H2" |
| 2027A x R3" | B2" x R3" x H1 ⁷ / ₈ " |

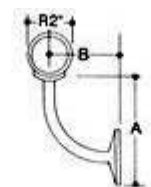

HANDRAIL SUPPORT RADIUSED

| Model No. | Size |
|-----------|--|
| 1528A | R1 ¹ / ₂ " x A3 ³ / ₄ " x B2 ¹ / ₂ " |
| 2028A | R2" x A3 ³ / ₄ " x B2 ¹ / ₂ " |

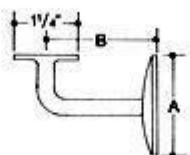

HANDRAIL SUPPORT FLAT TOP

| Model No. | Size |
|-----------|---|
| 2029A | B2 ¹ / ₂ " x A2 ¹ / ₂ " |

HANDRAIL & RAILING FITTINGS

WELLGROW INDUSTRIES CORP.

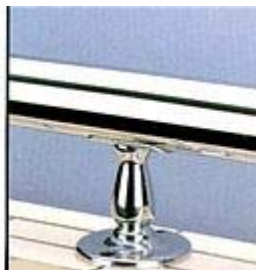
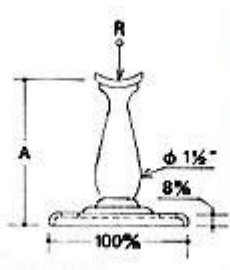

RAIL SUPPORT

| Model No. | Size |
|-----------|--|
| 2564A | B2 ¹ / ₂ " x A95 ^m /m |
| 3064A | B3" x A95 ^m /m |

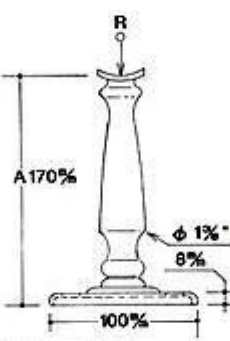

RAIL SUPPORT

| Model No. | Size |
|-----------|---|
| 2564 | R2 ¹ / ₂ " x A170 ^m /m |
| 3064 | R3" x A170 ^m /m |

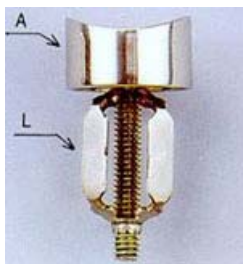

PERP. JOINER EXPANDING CAGE EXTERNAL FIT

| Model No. | Size |
|---------------------------------------|---------------------------------------|
| 313AL-1" | R1" ~ 3" |
| 313AL-1 ¹ / ₄ " | R1 ¹ / ₄ " ~ 3" |
| 313A-1 ¹ / ₂ " | R1 ¹ / ₂ " ~ 3" |
| 313AL-2" | R2" ~ 3" |
| 313AL-2 ¹ / ₂ " | R2 ¹ / ₂ " ~ 3" |
| 313AL-1" | R1" ~ 3" |

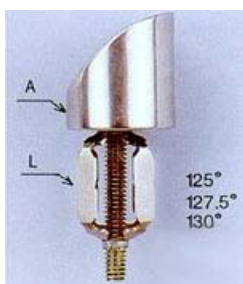

PERP. JOINER EXPANDING EXTERNAL CAP

| Model No. | Size |
|---------------------------------------|---------------------------------------|
| 314AL- 1" | R1" ~ 3" |
| 314AL-1 ¹ / ₄ " | R1 ¹ / ₄ " ~ 3" |
| 314AL-1 ¹ / ₂ " | R1 ¹ / ₂ " ~ 3" |
| 314AL-2" | R2" ~ 3" |
| 314AL-2 ¹ / ₂ " | R2 ¹ / ₂ " ~ 3" |

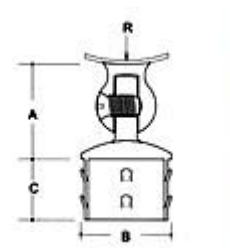

ADJ. RAIL SUPPORT RADIUSED INTERNAL FIT

| Model No. | Size |
|---|--|
| 315A-1" x R ¹ / ₂ " | B1"xR1 ¹ / ₂ "x A1 ¹ / ₄ "x C ³ / ₄ " |
| 315A-1" x R2" | B1"xR2"x A1 ¹ / ₄ "x C ³ / ₄ " |
| 315A-1 ¹ / ₄ " x R ¹ / ₂ " | B1 ¹ / ₄ "xR1 ¹ / ₂ "x A1 ¹ / ₄ "x C1" |
| 315A-1 ¹ / ₄ " x R2" | B1 ¹ / ₄ "xR2"x A1 ¹ / ₄ "x C1" |
| 315A-1 ¹ / ₂ " x R ¹ / ₂ " | B1 ¹ / ₂ "xR1 ¹ / ₂ "x A1 ³ / ₄ "x C ¹ / ₈ " |
| 315A-1 ¹ / ₂ " x R2" | B1 ¹ / ₂ "xR2"x A1 ³ / ₄ "x C ¹ / ₈ " |
| 315A-1 ¹ / ₂ " x R2 ¹ / ₂ " | B1 ¹ / ₂ "xR2 ¹ / ₂ "x A1 ³ / ₄ "x C ¹ / ₈ " |
| 315A-2" x R2" | B2"xR2"x A2"x C1 ¹ / ₂ " |
| 315A-2" x R2 ¹ / ₂ " | B2"xR2 ¹ / ₂ "x A2"x C1 ¹ / ₂ " |

HANDRAIL & RAILING FITTINGS

WELLGROW INDUSTRIES CORP.

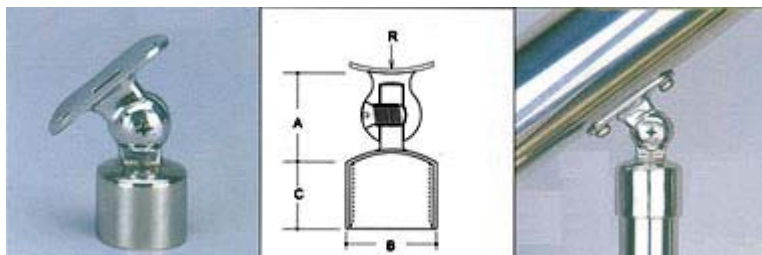

ADJ. RAIL SUPPORT RADIUS ED EXTERNAL FIT

| Model No. | Size |
|---|--|
| 316A-1" x R ^{1/2} " | B1"xR1 ^{1/2} "x A1 ^{1/4} "x C ^{3/4} " |
| 316A-1" x R2" | B1"xR2"x A1 ^{1/4} "x C ^{3/4} " |
| 316A-1 ^{1/4} " x R ^{1/2} " | B1 ^{1/4} "xR1 ^{1/2} "x A1 ^{1/4} "x C ^{3/4} " |
| 316A-1 ^{1/4} " x R2" | B1 ^{1/4} "xR2"x A1 ^{1/4} "x C ^{3/4} " |
| 316A-1 ^{1/2} " x R ^{1/2} " | B1 ^{1/2} "xR1 ^{1/2} "x A1 ^{1/2} "x C ^{7/8} " |
| 316A-1 ^{1/2} " x R2" | B1 ^{1/2} "xR2"x A1 ^{1/2} "x C ^{7/8} " |
| 316A-1 ^{1/2} " x R2 ^{1/2} " | B1 ^{1/2} "xR2 ^{1/2} "x A1 ^{1/2} "x C ^{7/8} " |
| 316A-2" x R2" | B2"xR2"x A2"x C1" |
| 316A-2" x R2 ^{1/2} " | B2"xR2 ^{1/2} "x A2"x C1" |
| 316A-2 ^{1/2} " x R3" | B2 ^{1/2} "xR3"x A2 ^{1/2} "x C1" |

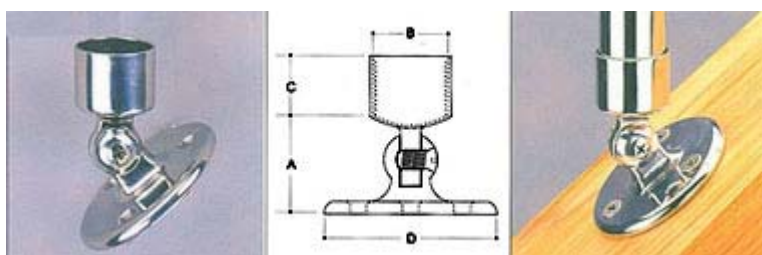

ADJ. RAIL SUPPORT ROUND BASE EXTERNAL FIT

| Model No. | Size |
|--------------------------|---|
| 316AC-1" | B1"x A1 ^{1/4} "x C ^{3/4} "x D2 ^{3/8} " |
| 316AC-1 ^{1/4} " | B1 ^{1/4} "x A1 ^{3/8} "x C ^{3/4} "x D2 ^{1/2} " |
| 316AC-1 ^{1/2} " | B1 ^{1/2} "x A1 ^{1/2} "x C ^{7/8} "x D3" |
| 316AC-2" | B2"x A2"x C1"x D4" |
| 316AC-2 ^{1/2} " | B2 ^{1/2} "x A2 ^{1/2} "x C1"x D5" |



ADJ. RAIL SUPPORT FLAT INTERNAL FIT

| Model No. | Size |
|-----------|---------------------|
| 315AP | resemble to SS:315A |

ADJ. RAIL SUPPORT FLAT EXTERNAL FIT

| Model No. | Size |
|-----------|---------------------|
| 316AP | resemble to SS:316A |

ADJ. RAIL SUPPORT ROUND BASE INTERNAL FIT

| Model No. | Size |
|-----------|----------------------|
| 315AC | resemble to SS:316AC |

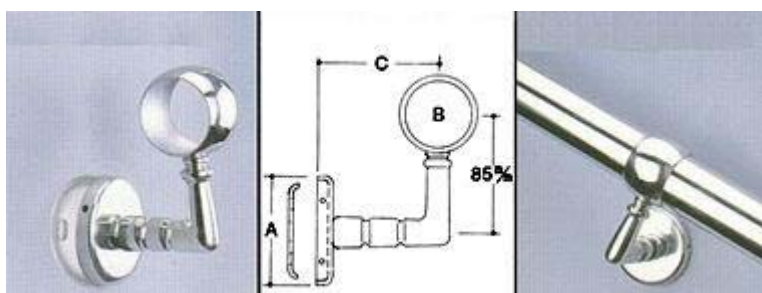

HANDRAIL CENTER SUPPORT

| Model No. | Size |
|-----------|---|
| 1233A | B1 ^{1/4} " x A65 ^m /m x C65 ^m /m |
| 1533A | B1 ^{1/2} " x A76 ^m /m x C70 ^m /m |
| 2033A | B2" x A76 ^m /m x C70 ^m /m |

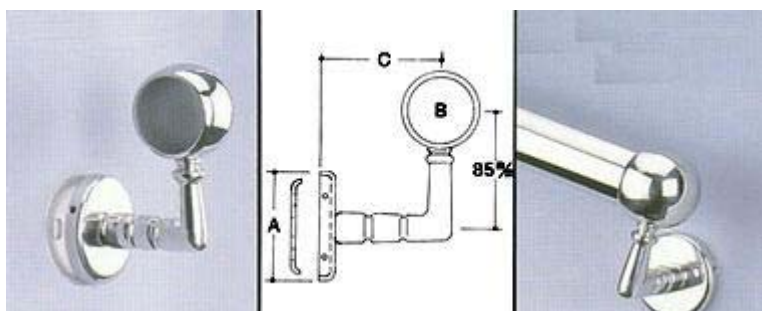

HANDRAILEND SUPPORT

| Model No. | Size |
|-----------|---|
| 1234A | B1 ^{1/4} " x A65 ^m /m x C65 ^m /m |
| 1534A | B1 ^{1/2} " x A76 ^m /m x C70 ^m /m |
| 2034A | B2" x A76 ^m /m x C70 ^m /m |

HANDRAIL & RAILING FITTINGS

WELLGROW INDUSTRIES CORP.

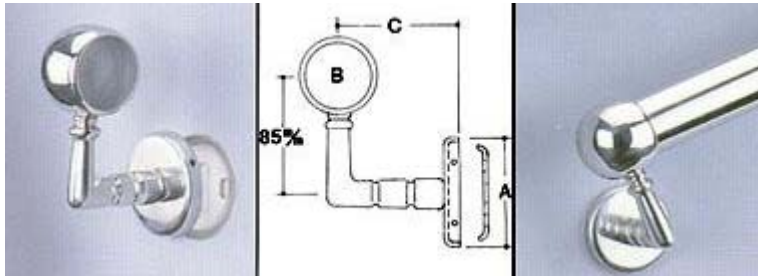

HANDRAIL END SUPPORT

| Model No. | Size |
|-----------|--|
| 1235A | B1 ¹ / ₄ " x A65 ^m /m x C65 ^m /m |
| 1535A | B1 ¹ / ₂ " x A76 ^m /m x C70 ^m /m |
| 2035A | B2" x A76 ^m /m x C70 ^m /m |

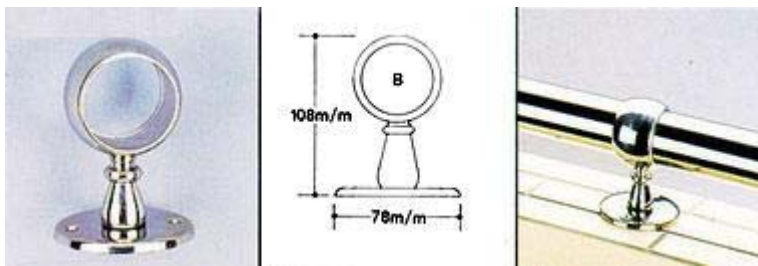

RAIL CENTER SUPPORT

| Model No. | Size |
|-----------|----------------------------------|
| 1543 | B1 ¹ / ₂ " |
| 2043 | B2" |

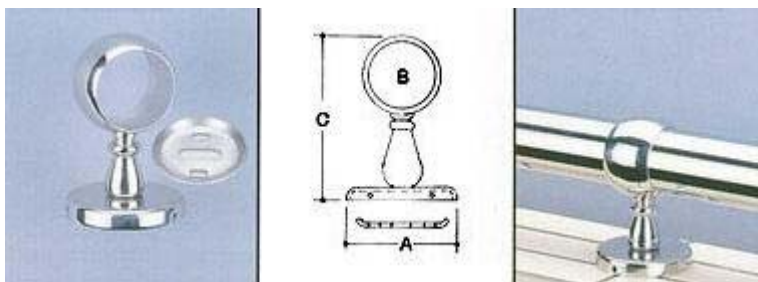

RAIL CENTER SUPPORT

| Model No. | Size |
|-----------|---|
| 1043A | B1" x A65 ^m /m x C85 ^m /m |
| 1243A | B1 ¹ / ₄ " x A65 ^m /m x C95 ^m /m |
| 1543A | B1 ¹ / ₂ " x A76 ^m /m x C105 ^m /m |
| 2043A | B2" x A76 ^m /m x C115 ^m /m |

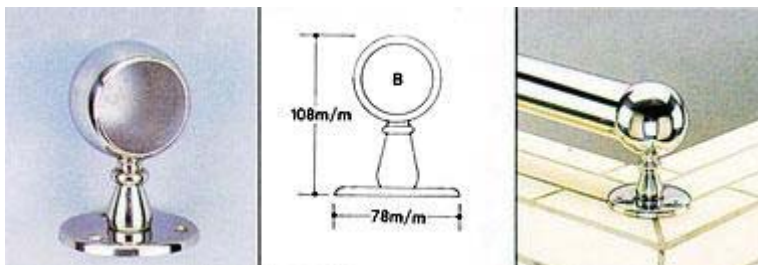

RAIL END SUPPORT

| Model No. | Size |
|-----------|----------------------------------|
| 1544 | B1 ¹ / ₂ " |
| 2044 | B2" |

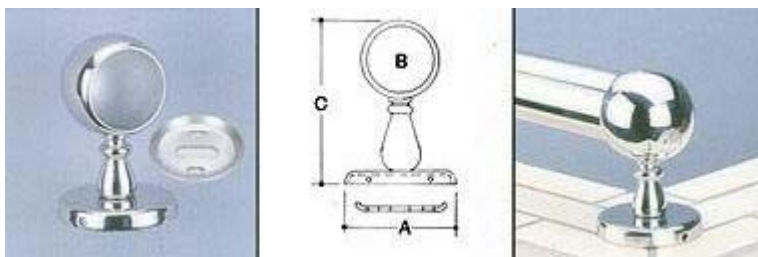

RAIL END SUPPORT

| Model No. | Size |
|-----------|---|
| 1044A | B1" x A65 ^m /m x C85 ^m /m |
| 1244A | B1 ¹ / ₄ " x A65 ^m /m x C95 ^m /m |
| 1544A | B1 ¹ / ₂ " x A76 ^m /m x C105 ^m /m |
| 2044A | B2" x A76 ^m /m x C115 ^m /m |

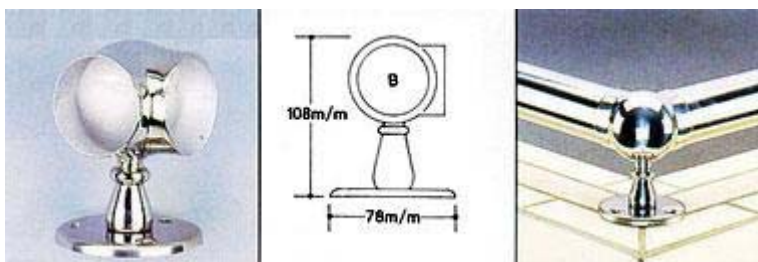

RAIL CENTER SUPPORT

| Model No. | Size |
|-----------|----------------------------------|
| 1545 | B1 ¹ / ₂ " |
| 2045 | B2" |

HANDRAIL & RAILING FITTINGS

WELLGROW INDUSTRIES CORP.

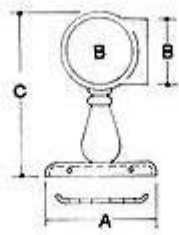

RAIL CENTER SUPPORT

| Model No. | Size |
|-----------|---|
| 1045A | B1" x A65 ^m /m x C85 ^m /m |
| 1245A | B1 ¹ / ₄ " x A65 ^m /m x C95 ^m /m |
| 1545A | B1 ¹ / ₂ " x A76 ^m /m x C105 ^m /m |
| 2045A | B2" x A76 ^m /m x C115 ^m /m |

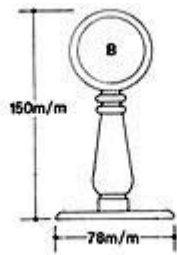

RAIL CENTER SUPPORT

| Model No. | Size |
|-----------|----------------------------------|
| 1546 | B1 ¹ / ₂ " |
| 2046 | B2" |

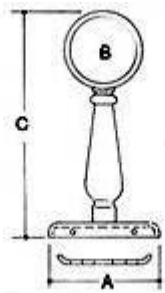

RAIL CENTER SUPPORT

| Model No. | Size |
|-----------|---|
| 1046A | B1" x A65 ^m /m x C125 ^m /m |
| 1246A | B1 ¹ / ₄ " x A65 ^m /m x C135 ^m /m |
| 1546A | B1 ¹ / ₂ " x A76 ^m /m x C145 ^m /m |
| 2046A | B2" x A76 ^m /m x C155 ^m /m |

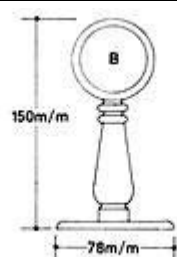

RAIL END SUPPORT

| Model No. | Size |
|-----------|----------------------------------|
| 1547 | B1 ¹ / ₂ " |
| 2047 | B2" |

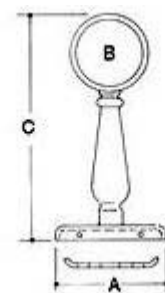

RAIL END SUPPORT

| Model No. | Size |
|-----------|---|
| 1047A | B1" x A65 ^m /m x C125 ^m /m |
| 1247A | B1 ¹ / ₄ " x A65 ^m /m x C135 ^m /m |
| 1547A | B1 ¹ / ₂ " x A76 ^m /m x C145 ^m /m |
| 2047A | B2" x A76 ^m /m x C155 ^m /m |

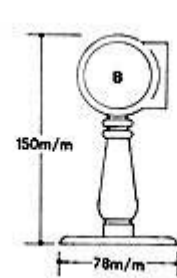

RAIL CENTER SUPPORT

| Model No. | Size |
|-----------|----------------------------------|
| 1548 | B1 ¹ / ₂ " |
| 2048 | B2" |

HANDRAIL & RAILING FITTINGS

WELLGROW INDUSTRIES CORP.

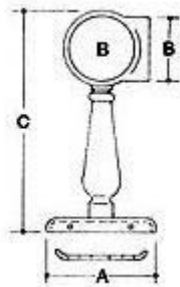

RAIL CENTER SUPPORT

| Model No. | Size |
|-----------|---|
| 1048A | B1" x A65 ^m /m x C125 ^m /m |
| 1248A | B1 ¹ / ₄ " x A65 ^m /m x C135 ^m /m |
| 1548A | B1 ¹ / ₂ " x A76 ^m /m x C145 ^m /m |
| 2048A | B2" x A76 ^m /m x C155 ^m /m |

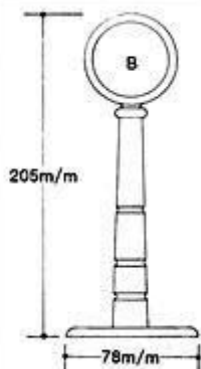

RAIL CENTER SUPPORT

| Model No. | Size |
|-----------|----------------------------------|
| 1549 | B1 ¹ / ₂ " |
| 2049 | B2" |

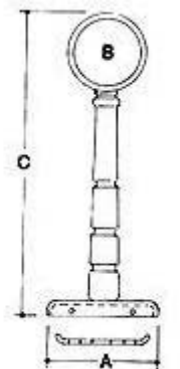

RAIL CENTER SUPPORT

| Model No. | Size |
|-----------|---|
| 1049A | B1" x A65 ^m /m x C183 ^m /m |
| 1249A | B1 ¹ / ₄ " x A65 ^m /m x C193 ^m /m |
| 1549A | B1 ¹ / ₂ " x A76 ^m /m x C203 ^m /m |
| 2049A | B2" x A76 ^m /m x C213 ^m /m |

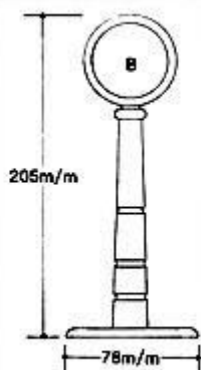

RAIL END SUPPORT

| Model No. | Size |
|-----------|----------------------------------|
| 1550 | B1 ¹ / ₂ " |
| 2050 | B2" |

HANDRAIL & RAILING FITTINGS

WELLGROW INDUSTRIES CORP.

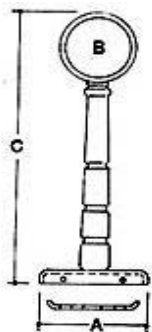

RAIL END SUPPORT

| Model No. | Size |
|-----------|---|
| 1050A | B1" x A65 ^m /m x C183 ^m /m |
| 1250A | B1 ¹ / ₄ " x A65 ^m /m x C193 ^m /m |
| 1550A | B1 ¹ / ₂ " x A76 ^m /m x C203 ^m /m |
| 2050A | B2" x A76 ^m /m x C213 ^m /m |

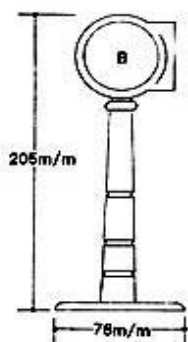

RAIL CENTER SUPPORT

| Model No. | Size |
|-----------|----------------------------------|
| 1551 | B1 ¹ / ₂ " |
| 2051 | B2" |

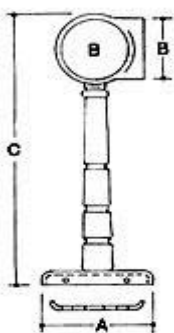

RAIL CENTER SUPPORT

| Model No. | Size |
|-----------|---|
| 1051A | B1" x A65 ^m /m x C183 ^m /m |
| 1251A | B1 ¹ / ₄ " x A65 ^m /m x C193 ^m /m |
| 1551A | B1 ¹ / ₂ " x A76 ^m /m x C203 ^m /m |
| 2051A | B2" x A76 ^m /m x C213 ^m /m |

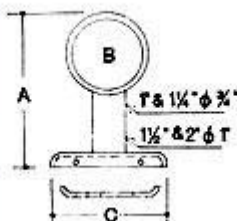

RAIL CENTER SUPPORT

| Model No. | Size |
|-----------|---|
| 1058A | B1" x A95 ^m /m x C65 ^m /m |
| 1258A | B1 ¹ / ₄ " x A95 ^m /m x C65 ^m /m |
| 1558A | B1 ¹ / ₂ " x A100 ^m /m x C78 ^m /m |
| 2058A | B2" x A100 ^m /m x C78 ^m /m |

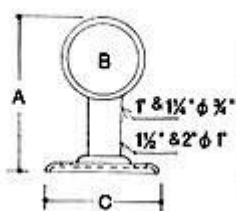

RAIL CENTER SUPPORT

| Model No. | Size |
|-----------|---|
| 1058B | B1" x A95 ^m /m x C65 ^m /m |
| 1258B | B1 ¹ / ₄ " x A95 ^m /m x C65 ^m /m |
| 1558B | B1 ¹ / ₂ " x A100 ^m /m x C78 ^m /m |
| 2058B | B2" x A100 ^m /m x C78 ^m /m |

HANDRAIL & RAILING FITTINGS

WELLGROW INDUSTRIES CORP.

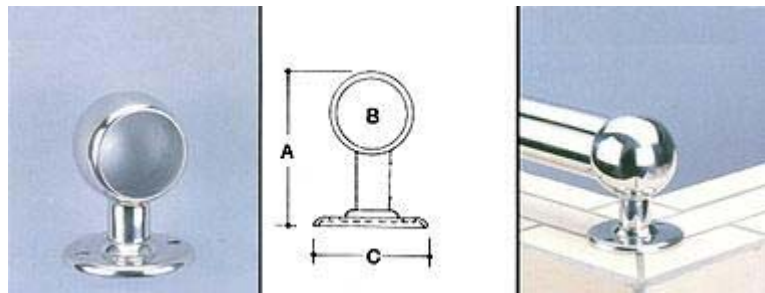

RAIL END SUPPORT

| Model No. | Size |
|-----------|---|
| 1059B | B1" x A95 ^m /m x C65 ^m /m |
| 1259B | B1 ¹ / ₄ " x A95 ^m /m x C65 ^m /m |
| 1559B | B1 ¹ / ₂ " x A100 ^m /m x C78 ^m /m |
| 2059B | B2" x A100 ^m /m x C78 ^m /m |

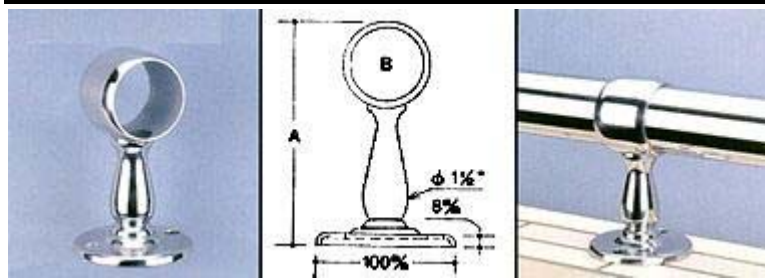

RAIL CENTER SUPPORT

| Model No. | Size |
|-----------|---|
| 2561A | B2 ¹ / ₂ " x A167 ^m /m |
| 3061A | B3" x A185 ^m /m |

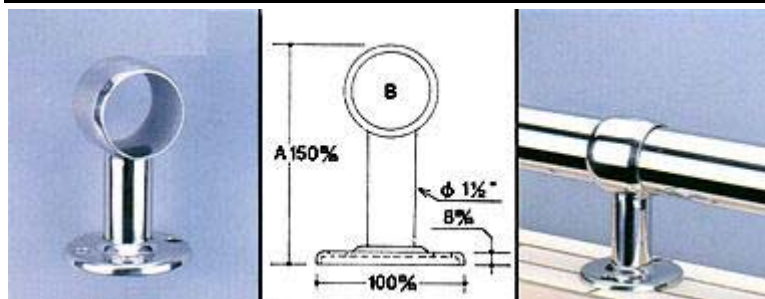

RAIL CENTER SUPPORT

| Model No. | Size |
|-----------|---|
| 2561B | B2 ¹ / ₂ " x A150 ^m /m |
| 3061B | B3" x A150 ^m /m |

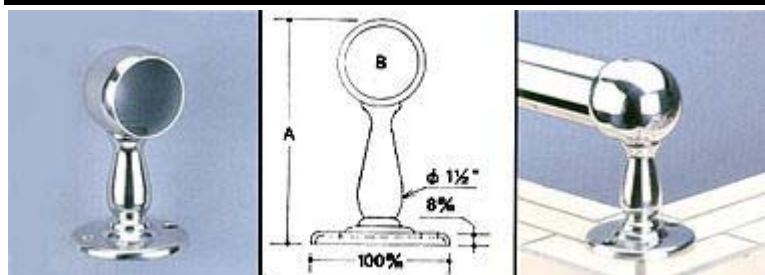

RAIL END SUPPORT

| Model No. | Size |
|-----------|---|
| 2562A | B2 ¹ / ₂ " x A167 ^m /m |
| 3062A | B3" x A185 ^m /m |

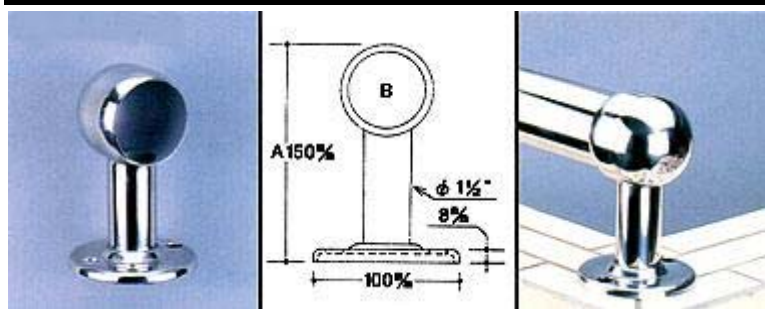

RAIL END SUPPORT

| Model No. | Size |
|-----------|---|
| 2562B | B2 ¹ / ₂ " x A150 ^m /m |
| 3062B | B3" x A150 ^m /m |

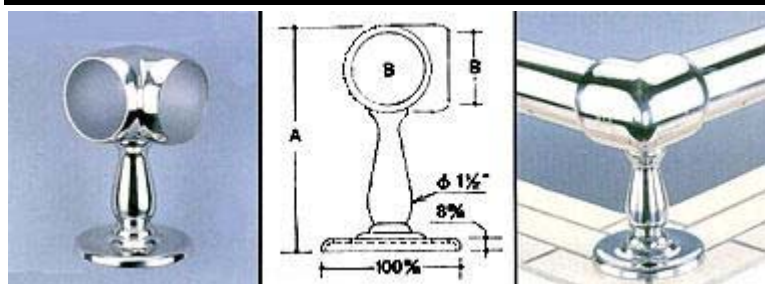

RAIL CENTER SUPPORT

| Model No. | Size |
|-----------|---|
| 2563A | B2 ¹ / ₂ " x A167 ^m /m |
| 3063A | B3" x A185 ^m /m |

HANDRAIL & RAILING FITTINGS

WELLGROW INDUSTRIES CORP.

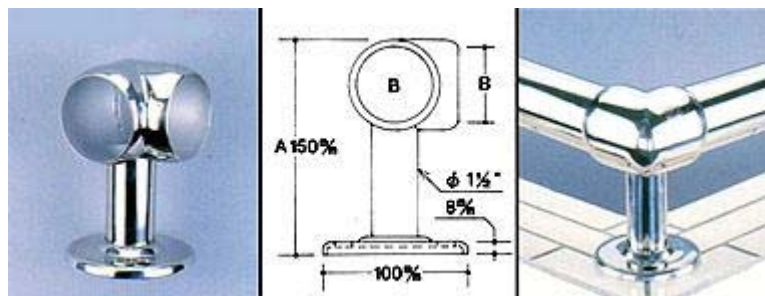

RAIL CENTER SUPPORT

| Model No. | Size |
|-----------|---|
| 2563B | B2 ¹ / ₂ " x A150 ^m /m |
| 3063B | B3" x A150 ^m /m |

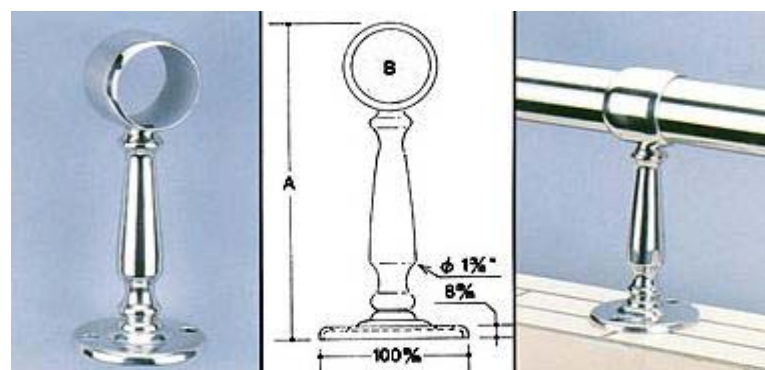

RAIL CENTER SUPPORT

| Model No. | Size |
|-----------|---|
| 2565 | B2 ¹ / ₂ " x A245 ^m /m |
| 3065 | B3" x A260 ^m /m |

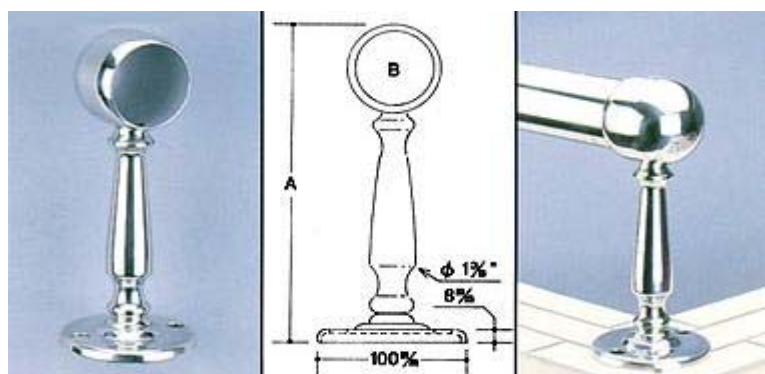

RAIL END SUPPORT

| Model No. | Size |
|-----------|---|
| 2566 | B2 ¹ / ₂ " x A245 ^m /m |
| 3066 | B3" x A260 ^m /m |

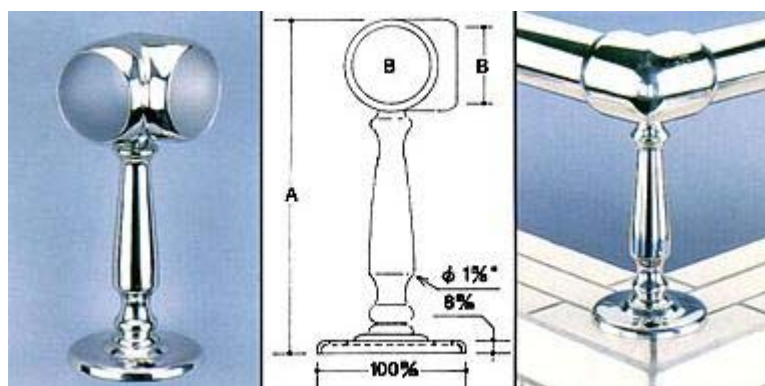

RAIL CENTER SUPPORT

| Model No. | Size |
|-----------|---|
| 2567 | B2 ¹ / ₂ " x A245 ^m /m |
| 3067 | B3" x A260 ^m /m |

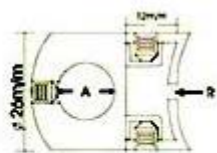

FIXING BASE RADIUSED

| Model No. | Size |
|--------------|--------------|
| 0474A-R11/2" | A1/2"xR11/2" |
| 0474A-R2" | A1/2"xR2" |
| 0474A-R21/2" | A1/2"xR21/2" |
| 0574A-R11/2" | A5/8"xR11/2" |
| 0574A-R2" | A5/8"xR2" |
| 0574A-R21/2" | A5/8"xR21/2" |

HANDRAIL & RAILING FITTINGS

WELLGROW INDUSTRIES CORP.



Hole, Plane Bottom

Holeless, Plane Bottom

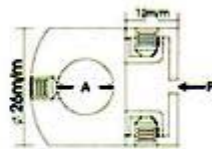

FIXING BASE PLANE

| Model No. | Size |
|---------------|--------------|
| 0474AP-R11/2" | A1/2"xR11/2" |
| 0474AP-R2" | A1/2"xR2" |
| 0474AP-R21/2" | A1/2"xR21/2" |
| 0574AP-R11/2" | A5/8"xR11/2" |
| 0574AP-R2" | A5/8"xR2" |
| 0574AP-R21/2" | A5/8"xR21/2" |



1075A

1075B

Hole, Arch Bottom

Holeless, Arch Bottom

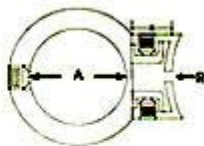

1075AP

1075BP

Hole, Plane Bottom

Holeless, Plane Bottom

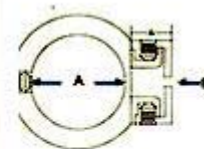

| Model No. | Size |
|-------------------|------------------------|
| 0675A/B(P)-R11/2" | A3/4"xR11/2"xW12.5m/m |
| 0675A/B(P)-R2" | A3/4"xR2"xW12.5m/m |
| 0675A/B(P)-R21/2" | A3/4"xR21/2"xW12.5m/m |
| 1075A/B(P)-R11/2" | A1"xR11/2"xW13m/m |
| 1075A/B(P)-R2" | A1"xR2"xW13m/m |
| 1075A/B(P)-R21/2" | A1"xR21/2"xW13m/m |
| 1275A/B(P)-R11/2" | A11/4"xR11/2"xW13.5m/m |
| 1275A/B(P)-R2" | A11/4"xR2"xW13.5m/m |
| 1275A/B(P)-R21/2" | A11/4"xR21/2"xW13.5m/m |
| 1575A/B(P)-R11/2" | A11/2"xR11/2"xW14m/m |
| 1575A/B(P)-R2" | A11/2"xR2"xW14m/m |
| 1575A/B(P)-R21/2" | A11/2"xR21/2"xW14m/m |
| 1575A/B(P)-R3" | A11/2"xR3"xW14m/m |
| 2075A/B(P)-R2" | A2"xR2"xW14.5m/m |
| 2075A/B(P)-R21/2" | A2"xR21/2"xW14.5m/m |
| 2075A/B(P)-R3" | A2"xR3"xW14.5m/m |
| 2575A/B(P)-R21/2" | A21/2"xR21/2"xW15m/m |
| 2575A/B(P)-R3" | A21/2"xR3"xW15m/m |

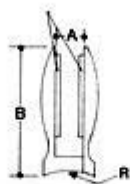

DROP SHAPE GLASS CLIP

| Model No. | Size |
|-----------|---|
| 0023A | A ¹ / ₂ "x B ² " |
| 1523A | R1 ¹ / ₂ " x A ¹ / ₂ " x B ² " |
| 2023A | R2" x A ¹ / ₂ " x B ² " |
| 2523A | R2 ¹ / ₂ " x A ¹ / ₂ " x B ² " |

HANDRAIL & RAILING FITTINGS

WELLGROW INDUSTRIES CORP.



END CAP LIGHT KNOCK-IN

| Model No. | Size (SS Electrolysis C) | Applicable Tube Thickness Range |
|-----------|---------------------------------|---------------------------------|
| 1030A | 1" | t0.6~1.2m/m |
| 1230A | 1 ¹ / ₄ " | t0.7~1.6m/m |
| 1530A | 1 ¹ / ₂ " | t0.8~2.0m/m |
| 2030A | 2" | t0.9~2.0m/m |
| 2530A | 2 ¹ / ₂ " | t1.0~2.5m/m |
| 3030A | 3" | t1.2~2.8m/m |

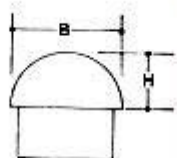

END CAP DOME

| Model No. | Size |
|-----------|---|
| 1518A | B1 ¹ / ₂ " x H19m/m |
| 2018A | B2" x H1" |

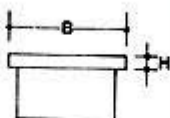

END CAP FLAT

| Model No. | Size |
|-----------|--|
| 1519A | B1 ¹ / ₂ " x H3.5m/m |
| 2019A | B2" x H4m/m |

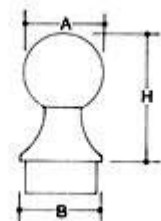

HANDRAIL BALL END

| Model No. | Size |
|---------------------------------------|--|
| 1521A-1 ¹ / ₂ " | B1 ¹ / ₂ " x A1 ¹ / ₂ " x H2 ¹ / ₄ " |
| 1521A-2" | B1 ¹ / ₂ " x A2" x H2 ³ / ₄ " |
| 1521A-2 ¹ / ₂ " | B1 ¹ / ₂ " x A2 ¹ / ₂ " x H3 ¹ / ₄ " |
| 1521A-3" | B1 ¹ / ₂ " x A3" x H3 ³ / ₄ " |
| 1521A-3 ¹ / ₂ " | B1 ¹ / ₂ " x A3 ¹ / ₂ " x H4 ¹ / ₄ " |
| 1521A-4 ¹ / ₄ " | B1 ¹ / ₂ " x A4 ¹ / ₄ " x H4 ¹ / ₂ " |
| 2021A-1 ¹ / ₂ " | B2" x A1 ¹ / ₂ " x H2 ¹ / ₂ " |
| 2021A-2" | B2" x A2" x H3" |
| 2021A-2 ¹ / ₂ " | B2" x A2 ¹ / ₂ " x H3 ¹ / ₂ " |
| 2021A-3" | B2" x A3" x H4" |
| 2021A-3 ¹ / ₂ " | B2" x A3 ¹ / ₂ " x H4 ¹ / ₂ " |
| 2021A-4 ¹ / ₄ " | B2" x A4 ¹ / ₄ " x H4 ³ / ₄ " |

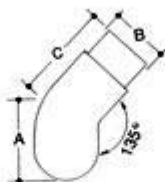

HANDRAIL END 45°

| Model No. | Size |
|-----------|--|
| 1525A | B1 ¹ / ₂ " x A2 ¹ / ₂ " x C2 ⁵ / ₈ " |
| 2025A | B2" x A2 ³ / ₄ " x C2 ³ / ₄ " |
| 2525A | B2 ¹ / ₂ " x A3 ¹ / ₂ " x C3 ¹ / ₂ " |

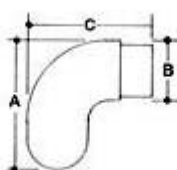

HANDRAIL END 90°

| Model No. | Size |
|-----------|--|
| 1526A | B1 ¹ / ₂ " x A3 ¹ / ₄ " x C3 ¹ / ₂ " |
| 2026A | B2" x A3 ¹ / ₂ " x C3 ¹ / ₂ " |
| 2526A | B2 ¹ / ₂ " x A4 ³ / ₈ " x C4" |
| 3026A | B3" x A4 ³ / ₈ " x C4" |